

成型孔:08W-3

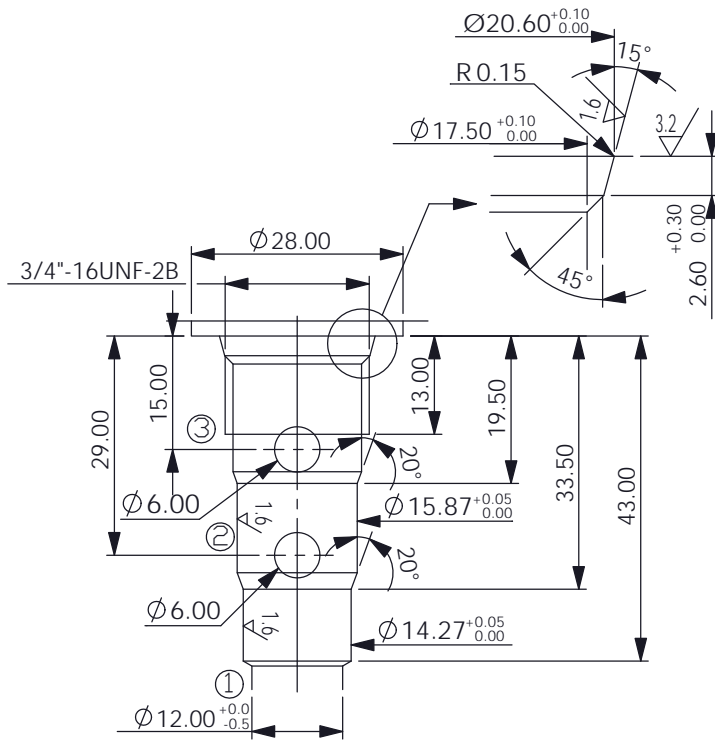

◎ 0.03

⊥ 0.02

尺寸單位:mm

成型孔:10W-3

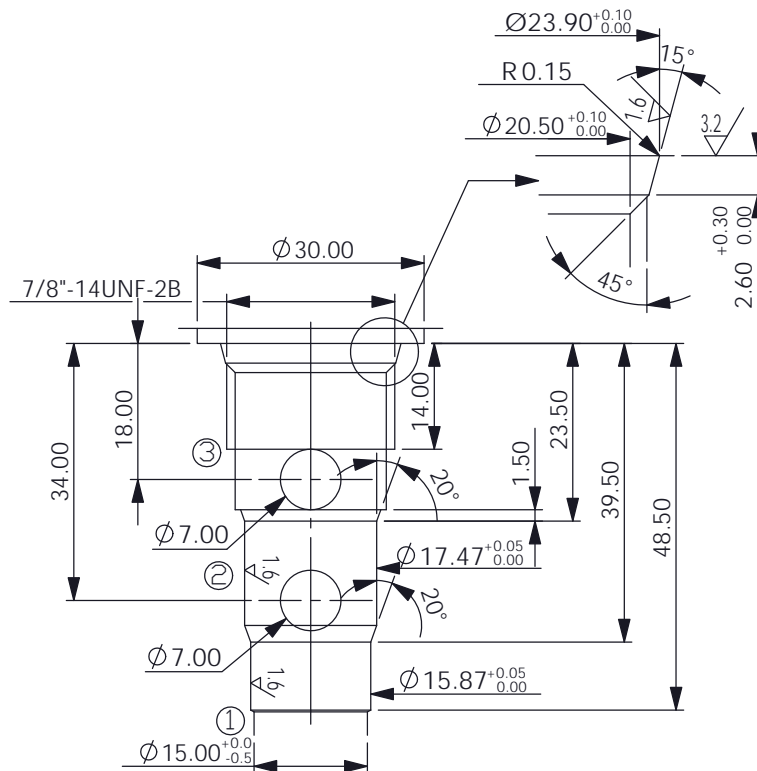

◎ 0.03

⊥ 0.02

尺寸單位:mm